

Ciběs



NEW GENERATION HOME LIFT

CIBES – SINCE 1947

Cibes Lift Group is one of the world's largest manufacturers of low-speed lifts, with sales and distribution in more than 70 countries, and a network of 200+ certified distributors.



WHAT MAKES CIBES SPECIAL?

DIRECT SALES ACROSS THE WORLD

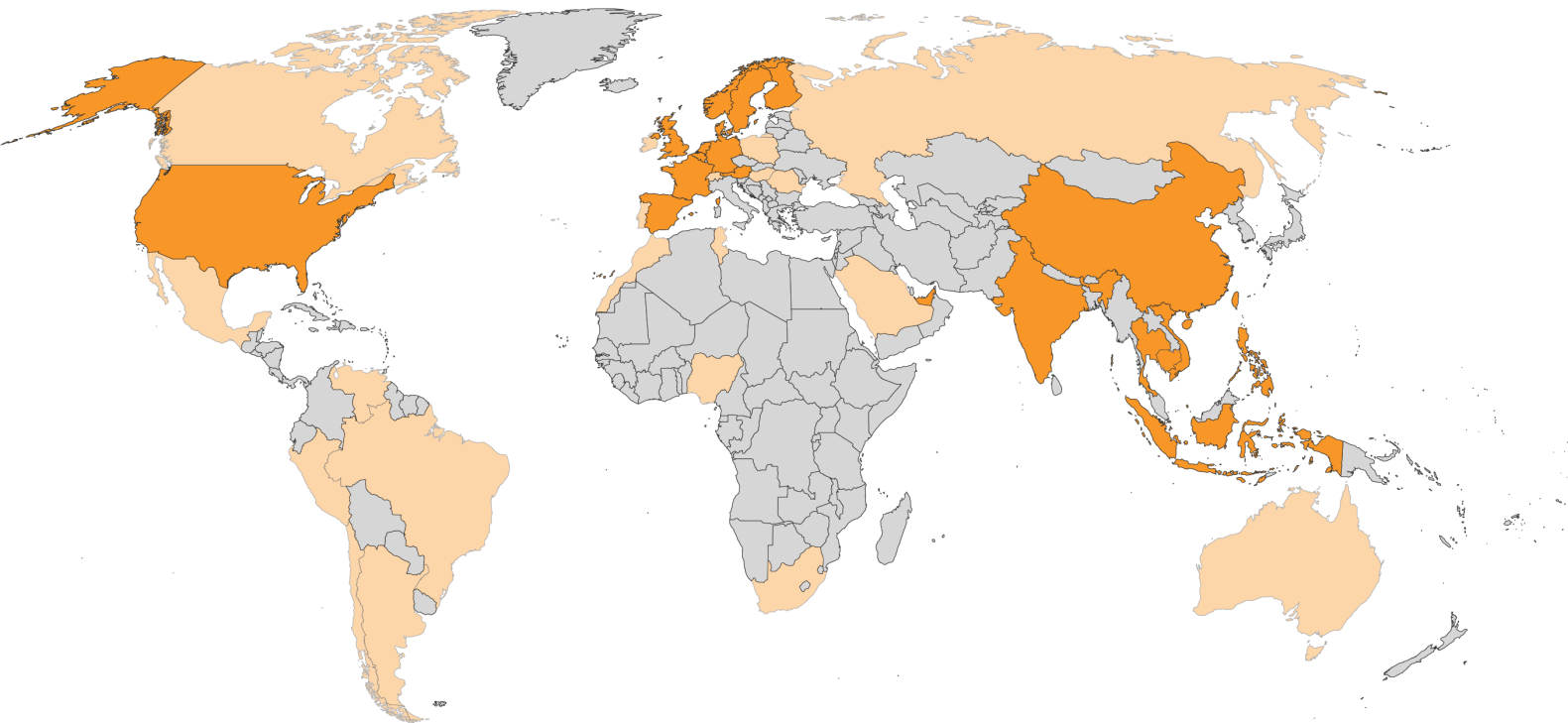

FACTORY DIRECT SUBSIDIARIES IN:

SWEDEN | NORWAY | FINLAND | FRANCE | UNITED KINGDOM | GERMANY | HOLLAND | SPAIN | AUSTRIA | BELGIUM | DUBAI | CHINA | VIETNAM | THAILAND | **CAMBODIA** | INDONESIA | PHILIPPINES | INDIA | USA

CIBES DIRECT OWNED FACTORIES

Gävle, SE | Jiaxing, CN | Roanoke, USA

APPROVED DEALERS IN:

70+ Countries

WORDS FROM OUR CEO,
PER LIDSTRÖM



One does not build a company that lasts over 70 years without an unwavering commitment to customer satisfaction. Cibes fully embraces the Scandinavian ethos of reliability, which is why we are uncompromising when it comes to the quality of our products, the elegance of our designs and our commitment to safety. From the start, our best marketing has always been our existing customers, and the 50,000 lifts we have installed around the world continue to be a driver of our success. At Cibes, we know that our happy customers are the key to our longevity, and we look forward to having you join the Cibes family!

Per Lidström

CEO, CIBES LIFT GROUP

ABOUT

CIBES LIFT GROUP IN 2022

210

MILLION EUROS

In turnover in 2021

1,590

EMPLOYEES

Across the world

70,000+

LIFTS INSTALLED

In 70+ countries

SPACE - SAVING TECHNOLOGY

NO MACHINE ROOM

Minimize civil works and able to open up on last floor without damage to roof area

ALL GLASS SHAFT

Able to do 360 glass shaft for a panoramic ride

SCREW DRIVE SYSTEM

Your lift is always attached to our screw and cannot "fall down".
Silent and energy efficient

SUPERIOR QUALITY

From our glass (laminated and tempered) to our shaft (aviation grade aluminum with premium custom powdercoat), every detail of our lift is carefully studied to offer the best quality.

TOUCH AND LIGHT

Our Cibes lifts come with full touchscreen to offer a modern design that can match any interior

PLATFORM DESIGN

Our lifts are platform lifts, which saves space, creates a feeling of openness and avoids locking you inside a cabin.

ANTI-STUCK SYSTEM

Battery back up, reset tag on door, phone and emergency openings – we have you covered even if the worst were to happen!

NO PIT

Installing our lift is simple – it requires no pit and can be installed straight on the floor with only a 50 mm ramp

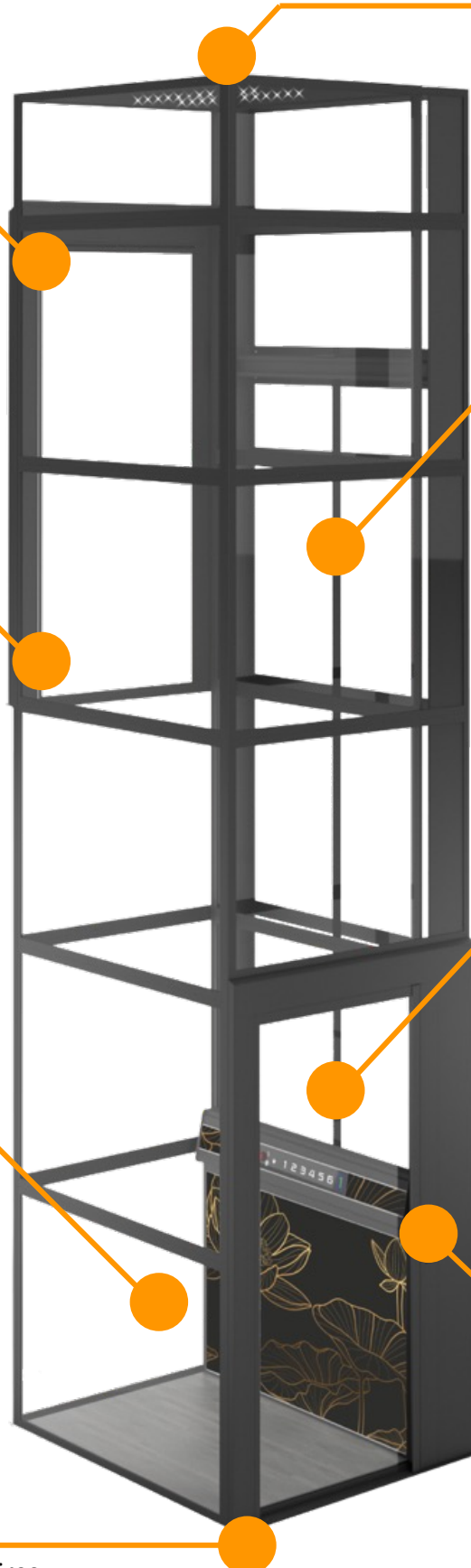

SAFETY IS IN OUR DNA

SWEDISH FOCUS ON QUALITY

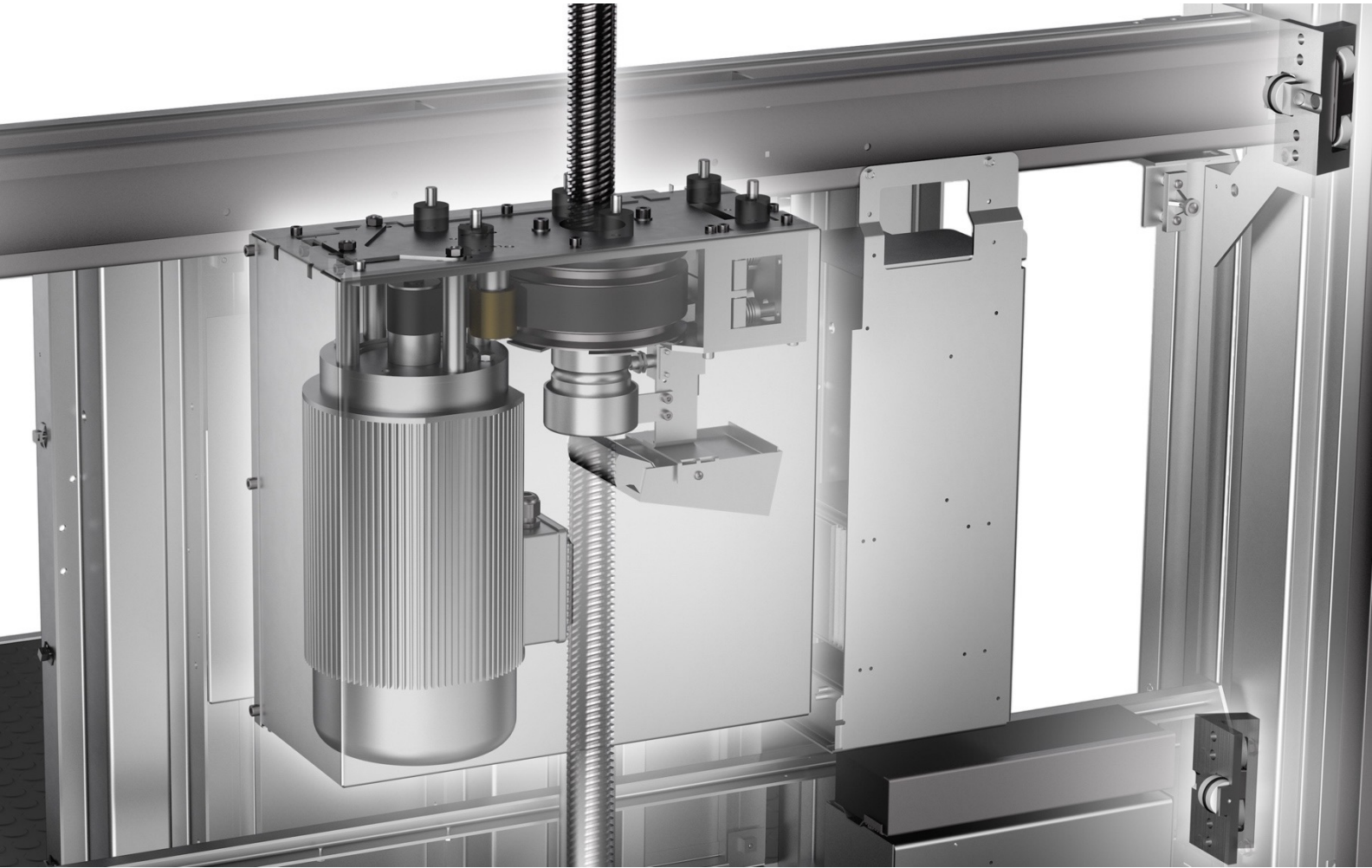

SCREW DRIVE TECHNOLOGY:

LIFTS THAT CANNOT “FALL DOWN”

Screw-drive technology is unique in the market in that the lifting cabin or platform is always attached to a toughened steel screw. The movement behind the “lifting” is not a pulling motion through cable or belt, but a rotation of a nut around the screw.

This revolutionary system ensures that Cibes Lift platforms and cabin cannot be “cut off” or enter freefall because of cable and brake failures. Instead, they are always connected to the steel screw that runs the length of the whole device.

Thanks to this technology, our screw drives are able to meet not only the extremely high European Safety Standards but also those of our other markets around the world, including but not limited to the USA and Australia.



CIBES
CIBES LIFT

HOME LIFTS

PLATFORM LIFTS

FIVE LEVELS OF CUSTOMIZATION



ELEGANCE

Simple and aesthetic with a touchscreen – elegance personified



AURORA

20+ light up design panels to choose from to perfectly match any home



GALAXY

2 laser-etched lighting options in RGBW complete with LiT shaft



ELEGANCE +

Elegance model upgraded with a high-power fan solution – ideal for outdoor



GALAXY +

Galaxy model upgraded with a high-power fan solution – ideal for outdoor



ELEGANCE



ELEGANCE PLATFORM



ELEGANCE FEATURES



Touchscreen



Dialpad
Phone



Emergency
Stop Button



Compact
Handrail

ELEGANCE SHAFT

1000 Glass Panels

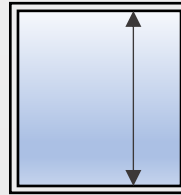

AL5 Glass Max Door

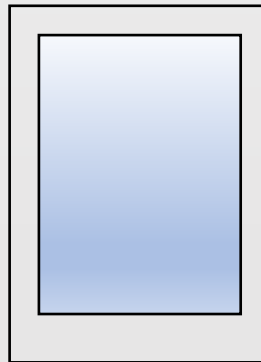

TECHNOLOGY



Screw Drive



EcoSilent



European EN81-41



AURORA



AURORA PLATFORM

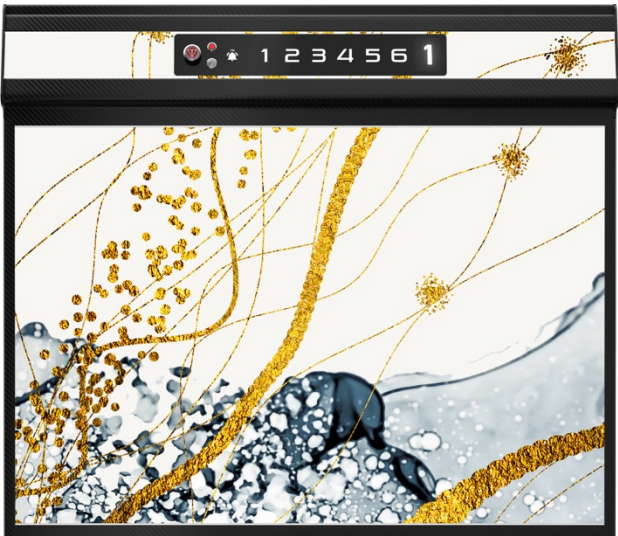

AURORA SHAFT

1200 Glass Panels

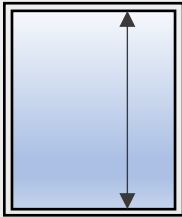

AL6 Glass Max Door

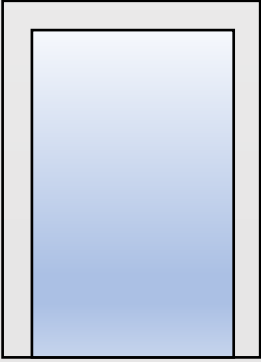

AURORA FEATURES



Touchscreen



Light Up Acrylic Panel



Dialpad Phone



Emergency Stop Button



Built-In Floor Level Ind.



Compact Handrail

TECHNOLOGY



Screw Drive



EcoSilent



European EN81-41



MINERAL SERIES - SANDSTONE CANYON



MINERAL SERIES - COBALT BLUE



GEOMETRY SERIES - VERONA



GEOMETRY SERIES - YEREVAN



MINERAL SERIES - GOLDEN TOPAZ



MINERAL SERIES - EVENING AGATE



GEOMETRY SERIES - INCA



GEOMETRY SERIES - EULER



MINERAL SERIES - NOVA CLOUDS



MINERAL SERIES - CLAY PARFAIT

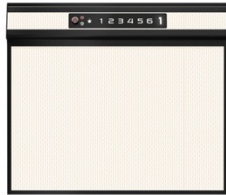

GEOMETRY SERIES - NEW ORLEANS



WATERCOLOR SERIES - TUSCAN SUN



MINERAL SERIES - BASILICA MARBLE



MINERAL SERIES - CINNABAR ROSE



CULTURE SERIES - LONG SPRING



CULTURE SERIES - DRAGON SEA



MINERAL SERIES - IMPERIAL BLACK



GEOMETRY SERIES - IONA



CULTURE SERIES - SEVEN ISLAND



CULTURE SERIES - PAVONA FEATHERS



20 unique
light-up patterns
to choose from!

GALAXY

GALAXY PLATFORM



GALAXY FEATURES



Touchscreen



Laser-Etched Design



Dialpad Phone



Emergency Stop Button



Built-In Floor Level Ind.

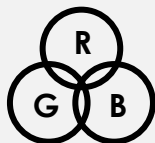

RGBW Lighting

GALAXY SHAFT

1200 Glass Panels

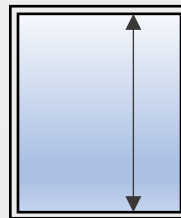

AL6 Glass Max Door

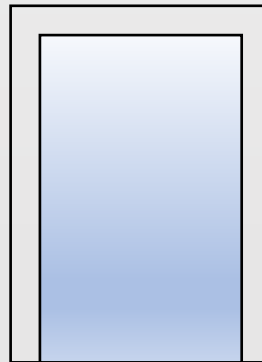

TECHNOLOGY



Screw Drive



EcoSilent



European EN81-41



ELEGANCE + GALAXY +



+ PLATFORM

+ SHAFT



+ LINE FEATURES



Touchscreen



Light Up Acrylic Panel



Dialpad Phone



Emergency Stop Button



Built-In Floor Level Ind.



High Power Fan

TECHNOLOGY



Screw Drive



EcoSilent



European EN81-41

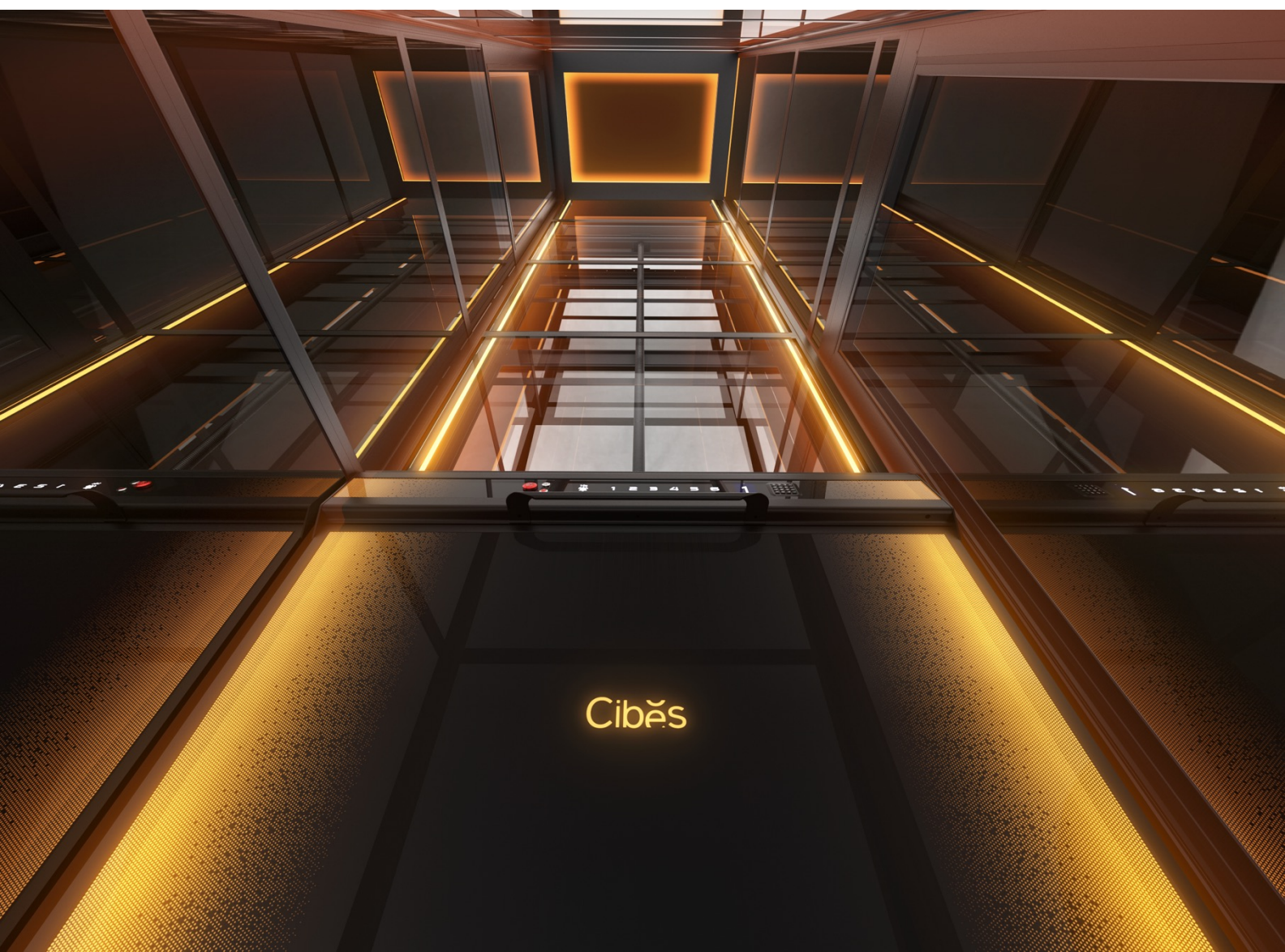

CUSTOMIZATION AND SIZES

	Platform Size (in mm)		Shaft Size (in mm)		Cut Out Size (in mm)	
	Width	Depth	Width	Depth	Width	Depth
XS	600	830	960	872	1020	980
S	800	830	1160	872	1220	980
S	900	830	1260	872	1320	980
S	1000	830	1360	872	1420	980
S	1100	830	1460	872	1520	980
S	800	930	1160	972	1220	1080
S	900	930	1260	972	1320	1080
S	1000	930	1360	972	1420	1080
S	1100	930	1460	972	1520	1080
M	800	1217	1160	1259	1220	1380
M	900	1217	1260	1259	1320	1380
M	1000	1217	1360	1259	1420	1380
M	1100	1217	1460	1259	1520	1380
M	800	1267	1160	1309	1220	1430
M	900	1267	1260	1309	1320	1430
M	1000	1267	1360	1309	1420	1430
M	1100	1267	1460	1309	1520	1430
L	800	1367	1160	1409	1220	1530
L	900	1367	1260	1409	1320	1530
L	1000	1367	1360	1409	1420	1530
L	1100	1367	1460	1409	1520	1530
L	800	1467	1160	1509	1220	1630
L	900	1467	1260	1509	1320	1630
L	1000	1467	1360	1509	1420	1630
L	1100	1467	1460	1509	1520	1630
XL	1100	1597	1460	1639	1520	1760

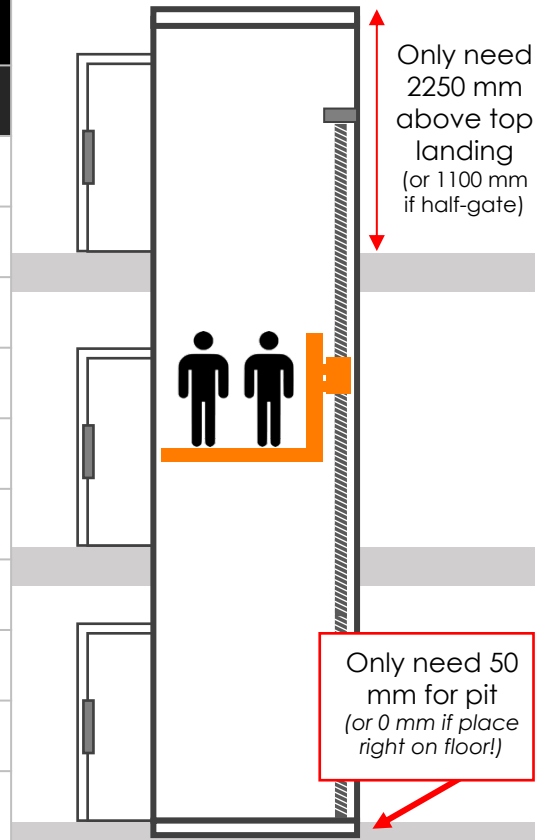

Premium Colors

Choose amongst our range of premium powdercoats with matte, metallic and sparkly finishes



Premium Carpets

Wood Series



Carpet Series



WHY CUSTOMERS CHOOSE CIBES

MEET OUR INSTALLATION TEAM



At Cibes, we **never outsource installation, maintenance and repairs**. All our technicians are Cibes-certified and trained directly by the head Cibes Tech Team.

This ensures that we maintain our high quality standards for every single lift we install, and provide our customers with top-notch customer service.

We also regularly arrange technical trainings across the region, sharing best practices from all our markets in Asia (100+ showrooms in 7 different countries).

OUR QUALITY PROMISE

- ▶ A Swedish quality lift deserves a **Swedish quality installation** – always!
- ▶ **24/7 service** – when you need us, we will be there!
- ▶ 1 year free warranty
- ▶ 1 year free maintenance
- ▶ 10 years limited warranty on the screw & nut
- ▶ **An investment** that will last 20-25 years when properly maintained by Cibes Certified Technicians

Technicians that are trained to not only repair and maintain your lift, but also respect your home and your privacy



"30% of Cibes' business is referrals, so complete customer satisfaction is the most important thing we focus on."

Kevin Der Arslanian
Director South East Asia



BASSAC GARDENS



CANADIA
BANK



BOREY VIMEAN
PHNOM PENH



Cibăș

PRIVATE HOME NEAR
OLYMPIA MALL



PRIVATE HOME
KAMPUCHEA KROM BLVD

Cibăș



Middle of Stairs
Aurora – Anodic Gold & Glacial Slate

CIBES PRODUCTION UNITS

DIRECT CONTROLLED

"It doesn't matter whether a Cibes is made in Sweden, the USA or China – all follow our extremely strict Swedish guidelines and conform to the toughest safety standards!"

**Chief Operating Officer
Samson Popowitz**

In charge of Gävle, Roanoke and Jiaxing Production Units



GÄVLE, SWEDEN

Opened in 2012, Gävle is our historic factory mostly focused on public and commercial accessibility lifts. It holds our R&D department and our QC.



FACTORY DIRECTOR:



Johan Wangberg
Head of
Production
Gävle

JIAXING, CHINA

Opened in 2020, Jiaxing is our state-of-the-art facility that produces high-end customized home lifts. It holds an Asia R&D center and training facility.



FACTORY DIRECTOR:



Juan Trespalacios
Head of
Production
Jiaxing

ROANOKE, USA

Established in 2014, our Roanoke facility produces lifts designed for the US and Latin America markets that follow the specific ASME standard



FACTORY DIRECTOR:



Rick Crane
Head of
Production
Roanoke



VIDEOS



BKK1
OUTDOOR
COMFORT

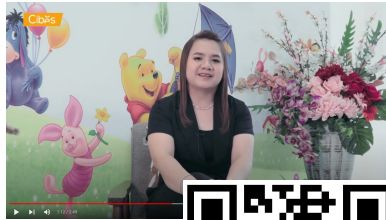

REVIEW
OUTDOOR
COMFORT



KAMPUCHEA
KROM BLV
AURORA



BASSAC
GARDENS
Review



MIDDLE OF
STAIRS
AURORA

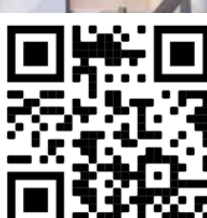

V90 GALAXY
ARCTIC ICE

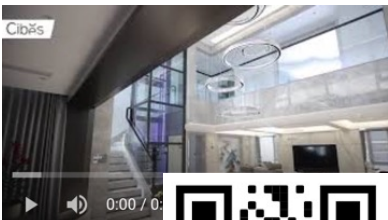

MIDDLE OF
STAIRS
GALAXY

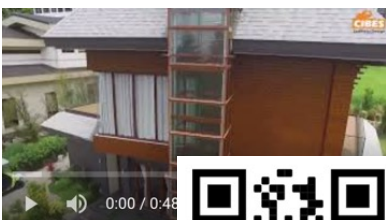

OUTDOOR
RESIDENTIAL
CLASSIC



SAFE FOR
CHILDREN
CLASSIC

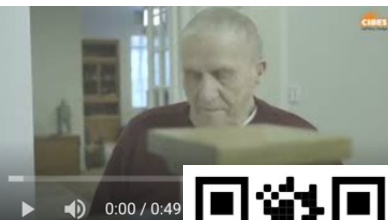

WHEELCHAIR
USER
CLASSIC



SIDEWALL
AURORA



PENTHOUSE
LIFT
AURORA



Ciběš